











| | | | |
|---|---|-------|----|
| A |  | 4*30 | 54 |
| B |  | M6*40 | 18 |
| C |  | | 2 |
| D |  | Φ8*30 | 16 |
| E |  | Φ7*60 | 4 |
| F |  | M6*60 | 6 |
| G |  | M6*60 | 24 |
| H |  | | 1 |

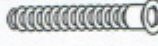

STEP:1

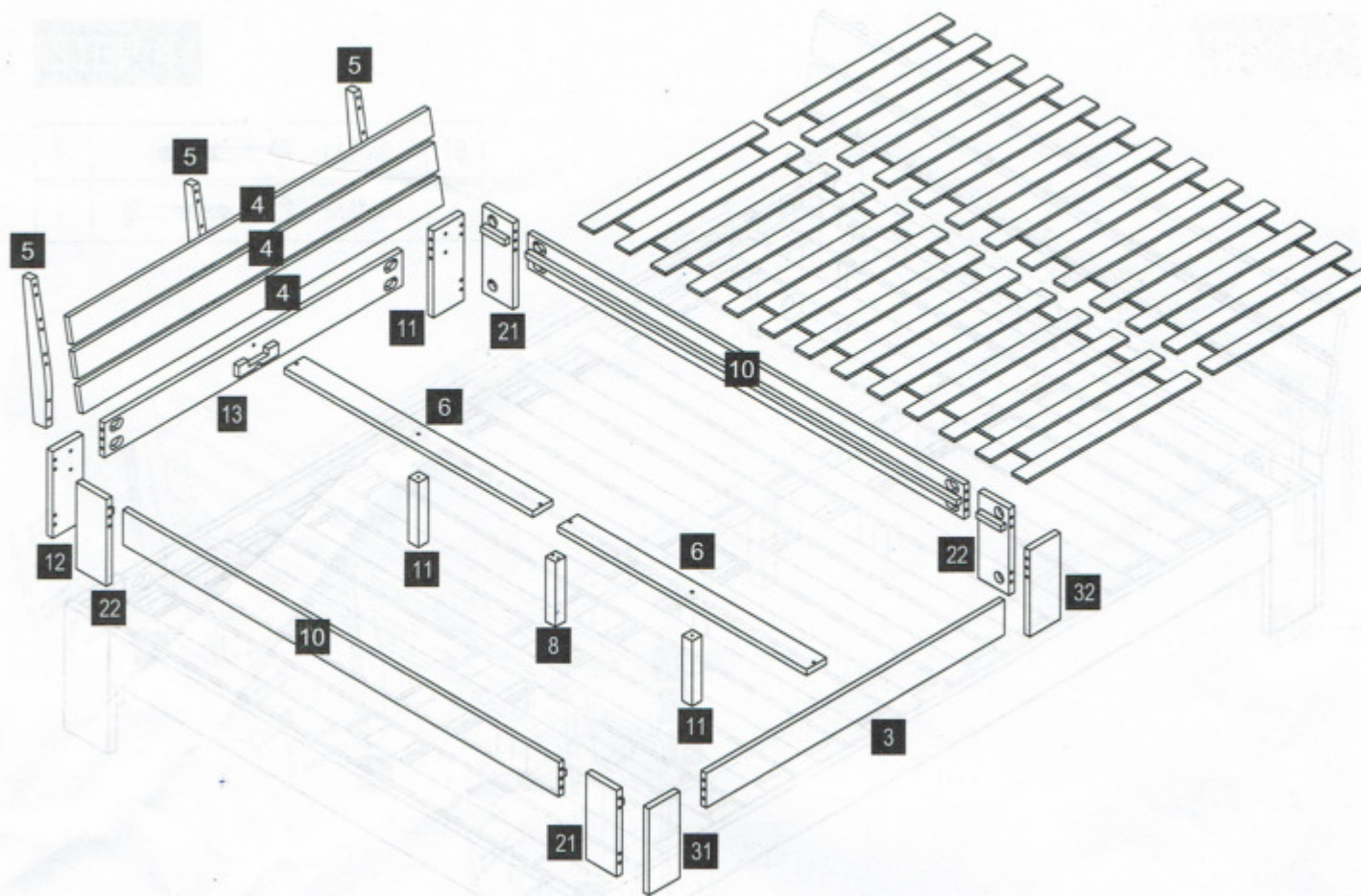
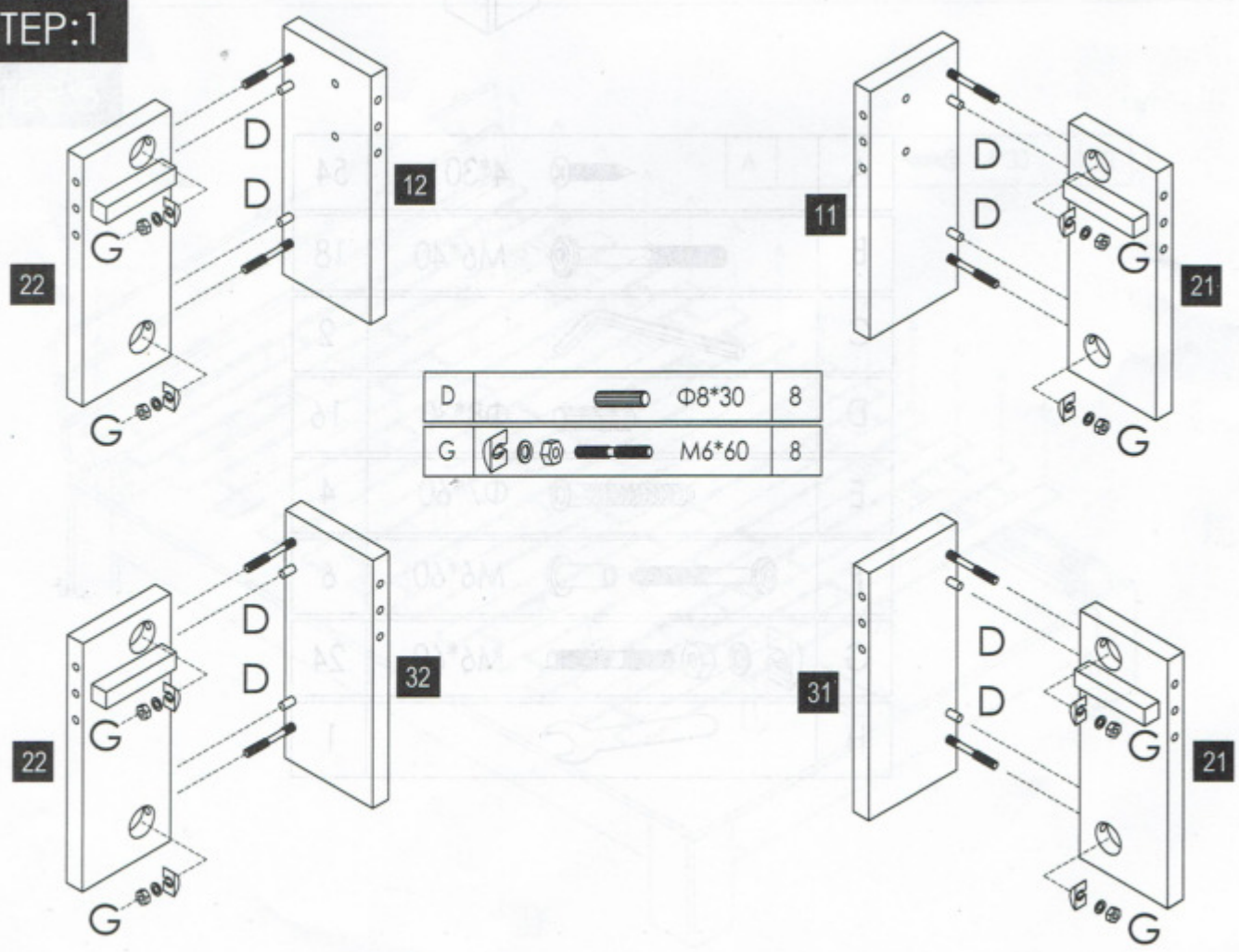

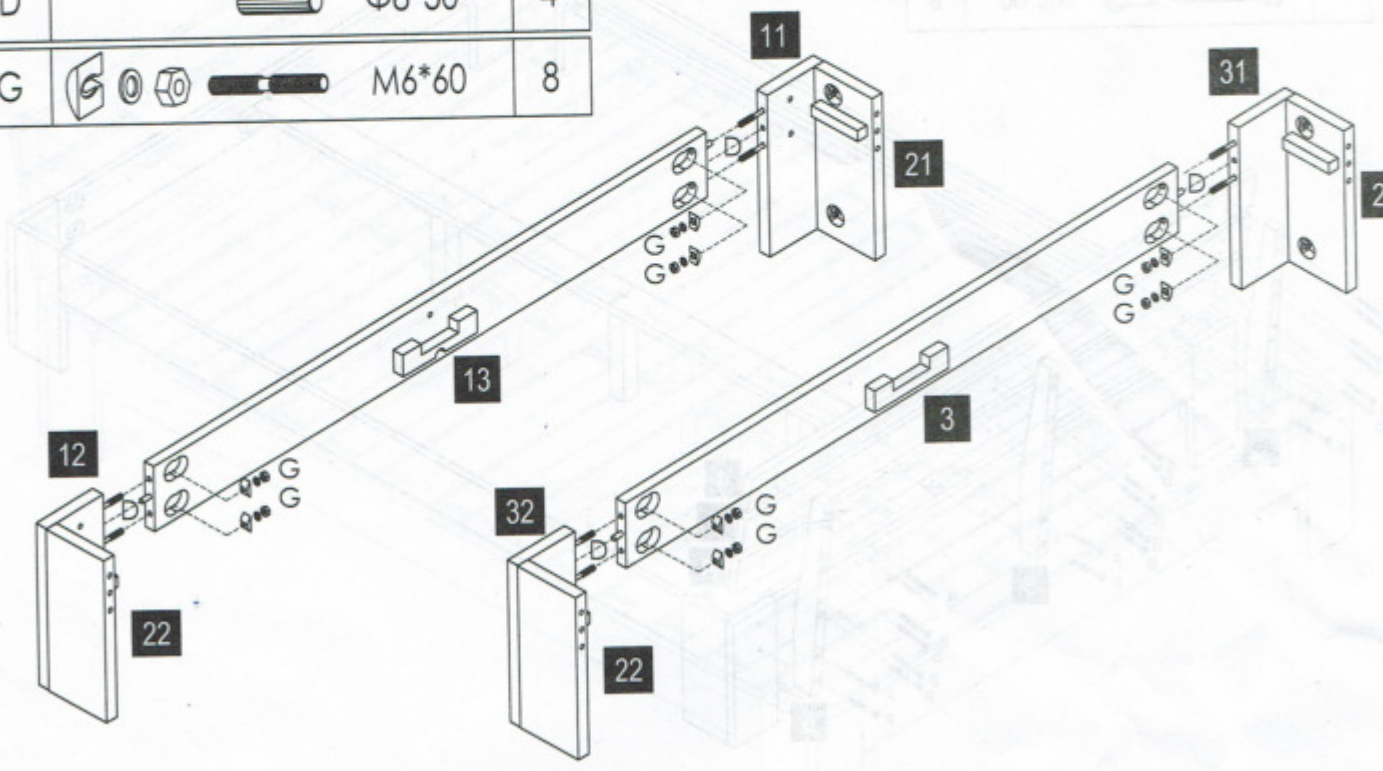

STEP:2

| | | | |
|---|---|-------|---|
| D |  | Φ8*30 | 4 |
| G |  | M6*60 | 8 |



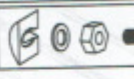

STEP:3

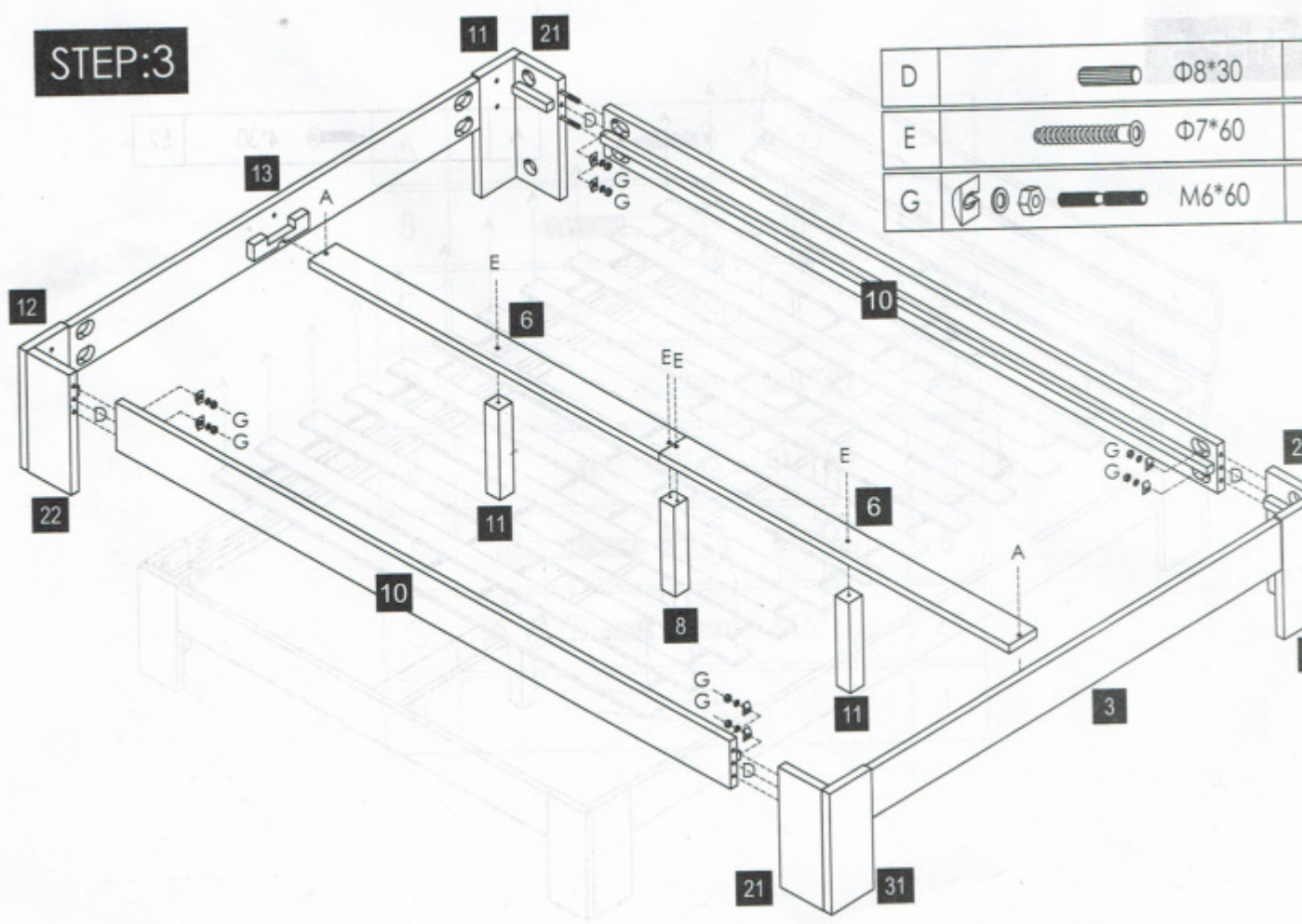
| | | | |
|---|---|-------|---|
| D |  | Φ8*30 | 4 |
| E |  | Φ7*60 | 2 |
| G |  | M6*60 | 8 |



STEP:4

| | | | |
|---|---|-------|----|
| B |  | M6*40 | 18 |
| F |  | M6*60 | 6 |

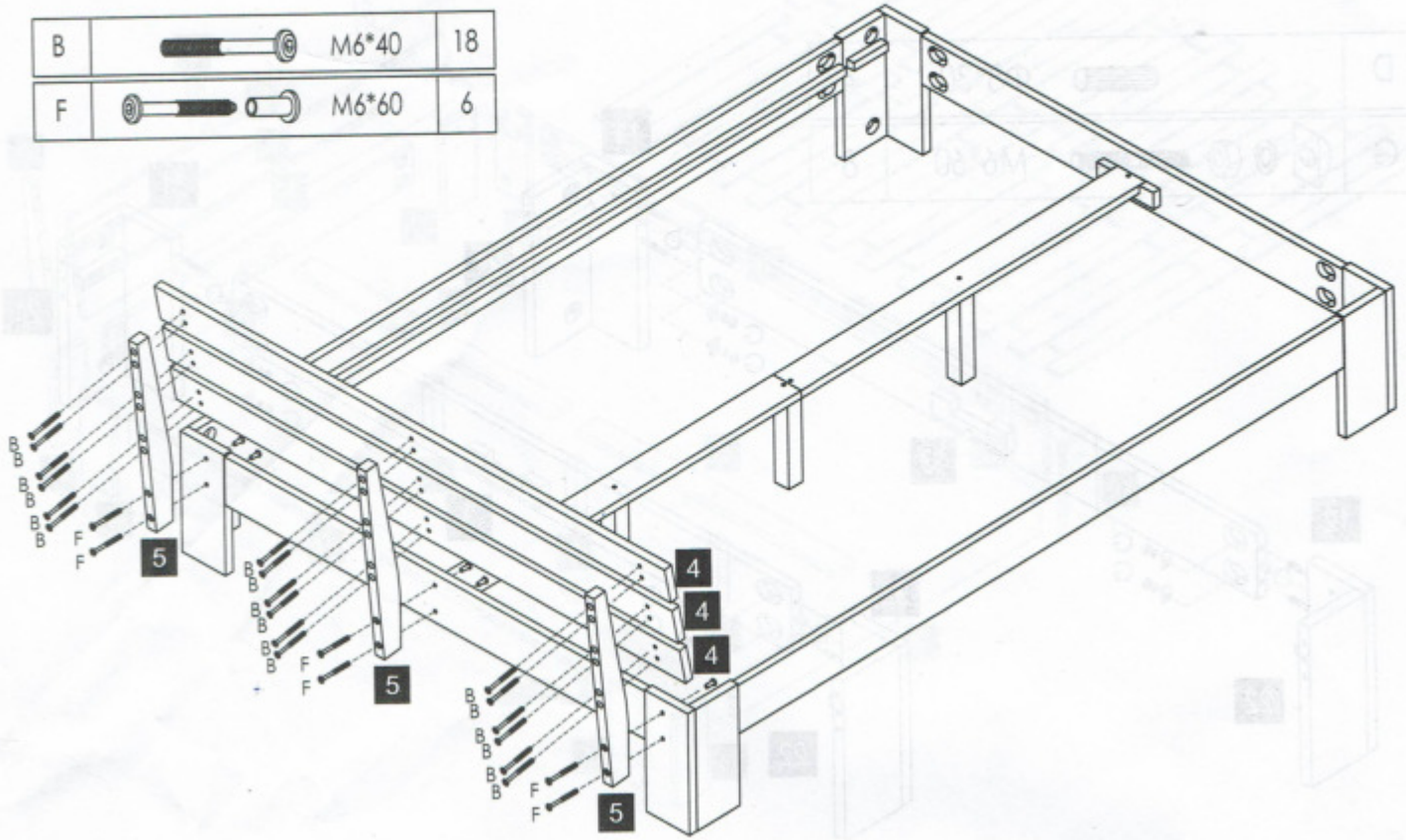

STEP:5

| | | | |
|---|---|------|----|
| A |  | 4*30 | 52 |
|---|---|------|----|

